

INSTALLATION INSTRUCTIONS

FTS21302		3" CANYON/COLORADO UNIBALL UCA KIT
1	FT21001	UPPER CONTROL ARM (DRIVER)
1	FT21002	UPPER CONTROL ARM (PASSENGER)
1	FT21003	HARDWARE SUBASSEMBLY

FT21003		HARDWARE SUBASSEMBLY
4	FT1037	BUSHING
4	FT1038	BUSHING
1	FT21011	HARDWARE KIT
1	FT21302i	INSTRUCTIONS
4	FT646	SLEEVE
4	FT84	GREASE FITTING
2	FT90152	MISALIGNMENT SPACER (UPPER)
2	FT90153	MISALIGNMENT SPACER (LOWER)
1	FT90154	BEARING CAP KIT
2	FT94538	UNIBALL ADAPTER PIN L
1	FTAS12	STICKER
1	FTAS16	DRIVER WARNING DECAL
1	FTLUBE	URETHANE LUBE PACKET
1	FTREGCARD	REGISTRATION CARD

FT21011 - HARDWARE KIT		LOCATION
4	1/4-20 C-LOCK NUT	
4	1/4-20 X 3/4" HEX BOLT	
2	1/2-20 X 1" FERRY CAP BOLT	
2	9/16" SAE FLAT WASHER	
2	9/16-18 C-LOCK NUT	
4	CUSHIONED CLAMP	
1	THREAD LOCKING COMPOUND	

2024 GM CANYON/COLORADO 4WD 3" UNIBALL UPPER CONTROL ARM KIT

FTS21302

NOTE: TO ORDER WEARABLE REPLACEMENT COMPONENTS DO NOT USE PART NUMBERS SHOWN ON THIS INSTRUCTION SHEET. GO TO FABTECH WEBSITE AND LOOK UP WEARABLE REPLACEMENT PARTS TO FIND THE PROPER PART NUMBER TO ORDER.

Fabtech Motorsports | 2213 Industrial Park Rd. Lancaster, SC 29720

Tech Line: 909-597-7800 | Web: www.fabtechmotorsports.com

- TOOL LIST -

Required Tools (Not Included)

Basic Hand Tools
Floor Jack
Jack Stands
Assorted Metric and S.A.E sockets, and Allen wrenches
Torque Wrench

- PRE-INSTALLATION NOTES -

For technical assistance call: **909-597-7800** or e-mail: **info@fabtechmotorsports.com**

READ THIS BEFORE YOU BEGIN INSTALLATION -

Check all parts to the parts list above before beginning installation. If any parts are missing contact Fabtech at 909-597-7800 and a replacement part will be sent to you immediately.

This suspension and shocks have been designed to be installed on a stock vehicle.

Read all instructions thoroughly from start to finish before beginning the installation. If these instructions are not properly followed severe frame, driveline and / or suspension damage may occur.

Check your local city and state laws prior to the installation of this system for legality. Do not install if not legal in your area.

Prior to the installation of this suspension system perform a front end alignment and record. Do not install this system if the vehicle alignment is not within factory specifications. Check for frame and suspension damage prior to installation.

The installation of this suspension system should be performed by two professional mechanics. This suspension must be installed with Fabtech shock absorbers.

Installation of all fasteners requires the use of provided thread locking compound with proper torque values as indicated throughout the installation. Apply thread locking compound upon the final torque of the fastener.

WARNING- Installation of this system will alter the center of gravity of the vehicle and may increase roll over as compared to stock. Extreme care should be taken to operate the vehicle safely at all times to prevent rollover or loss of control resulting in serious injury or death.

Vehicles that receive oversized tires should check ball joints, uniballs, tie rods ends, pitman arm and idler arm every 2500-5000 miles for wear and replace as needed.

Verify differential fluid is at manufactures recommended level prior to kit installation. Installation of the kit will reposition the differential and the fill plug hole may be in a different position. (For example, if the manufacture recommends 3 quarts of fluid, make sure the diff has 3 quarts of fluid). Check your specific manual for correct amount of fluid.

Read all warnings and warranties on the last page of these instructions before starting installation.

FOOTNOTES -

- Some models may not sit level after install

-

- INSTRUCTIONS -

1. Disconnect the negative terminal on the battery. Jack up the front end of the truck and support the frame rails with jack stands. **NEVER WORK UNDER AN UNSUPPORTED VEHICLE!** Remove the front tires.
2. Starting on the drivers side. Disconnect the sway bar from the lower control arm and the Tie rod end from the factory knuckle. Disconnect the ABS/Bracke line from the factory upper control arm. Loosen but do not remove the upper ball joint nut. Disconnect the upper ball joint from the knuckle by striking the knuckle with a large hammer next to the upper ball joint on the knuckle to dislodge the ball joints. Use care not to hit the ball joints when removing. **SEE FIGURE 1**

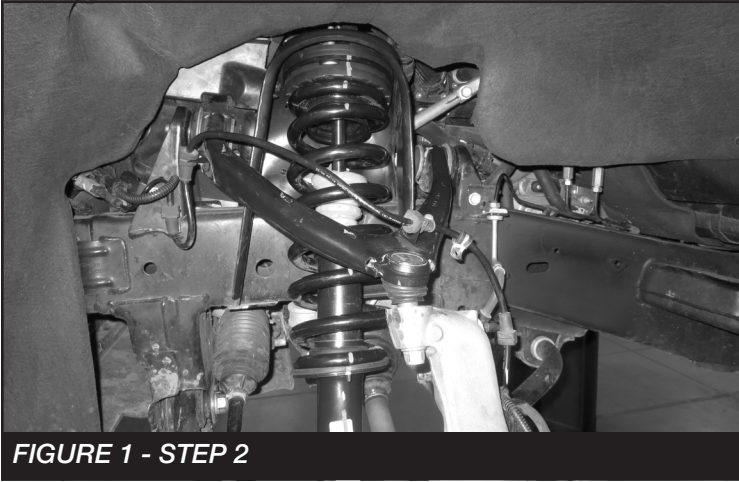

3. Remove the upper control arm and retain the factory hardware.
4. If installing Dirt Logic Coilovers or Fabtech Spacer kit. Do so with the provided instructions at this time. Then, return to Step 8 on these instructions.
5. Locate the new Fabtech control arms, two (FT1037) bushings, two (FT1038) bushings, two (FT84) grease zerks, and two (FT646) sleeves. Install the components into the new control arms. **SEE FIGURE 2**

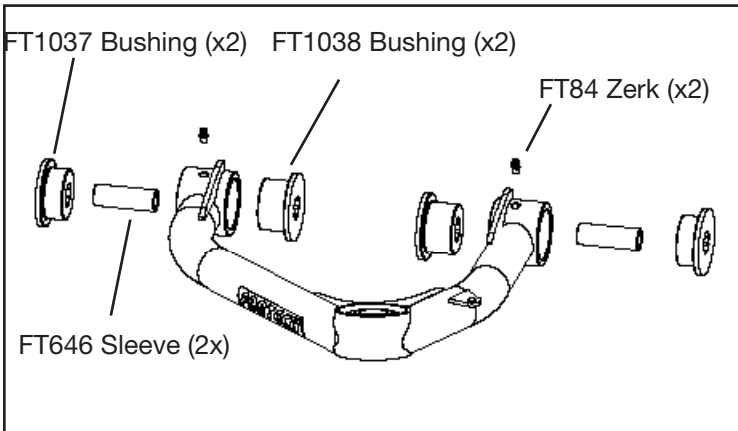

FIGURE 2 - STEP 5

6. Install the upper arm using the factory hardware. **NOTE:** Install the factory bolts from the inside of the bucket. **NOTE:** When installing the arm on the truck make sure the barrel gussets are up. Torque to 128 ft-lbs. **SEE FIGURES 3-5**

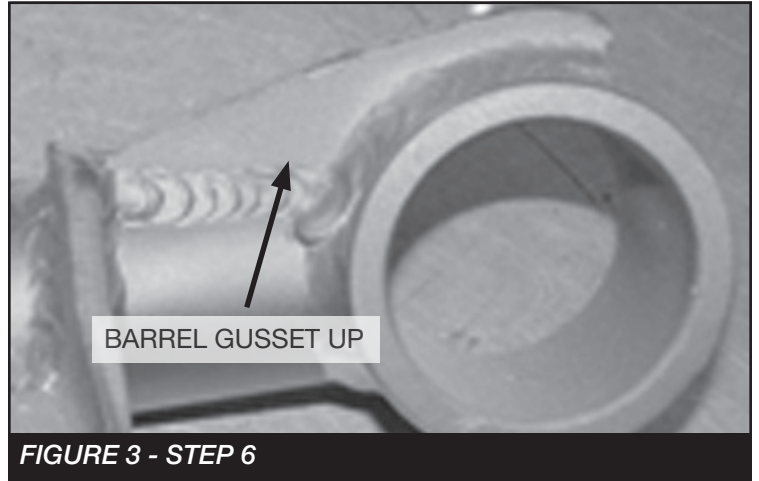

FIGURE 3 - STEP 6

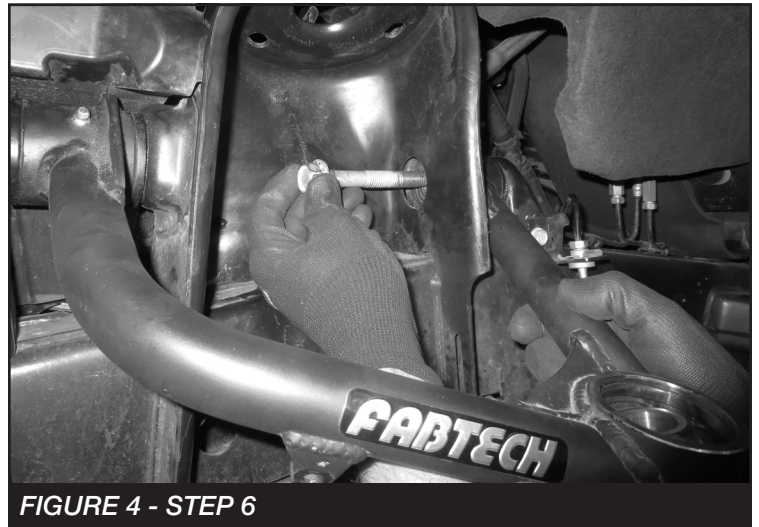

FIGURE 4 - STEP 6



FIGURE 5 - STEP 6

7. Install FT90153 (Lower misalignment) onto FT94538 (Uniball Pin). Then, install into the factory control arm using the supplied 9/16" nut, washer. Torque the nut to 135 ft-lbs. **SEE FIGURE 6**

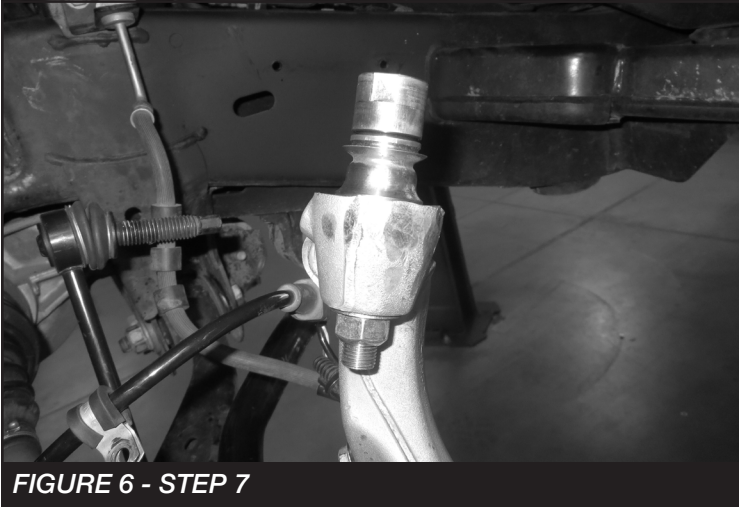

FIGURE 6 - STEP 7

8. Attach the new upper control arm to the knuckle by inserting the FT90152 (Upper misalignment) into the uniball bearing then the 1/2-20 - 12 point bolt. Torque to 106 ft-lbs. Install FT90154 (Bearing cap). Torque the control arm pivot bolt to 148 ft-lbs **SEE FIGURES 7-8**



FIGURE 7 - STEP 8

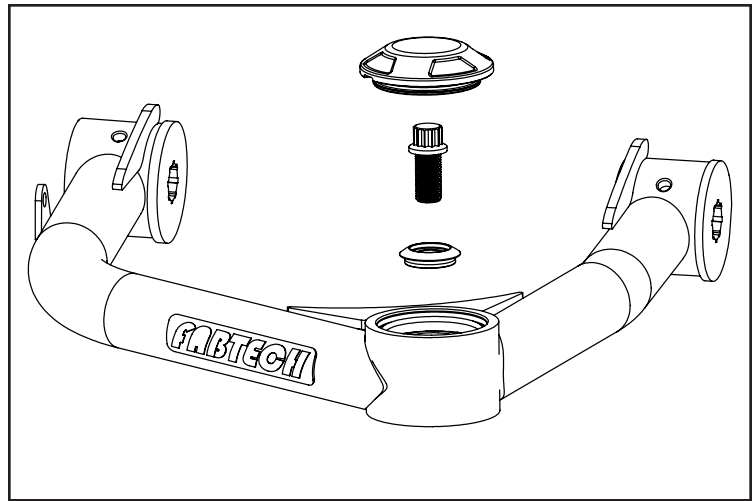

FIGURE 8 - STEP 8

9. Install the ABS line to the new upper control arm using the supplied clamps and 1/4" hardware. Torque to 10 ft-lbs. **SEE FIGURE 9**

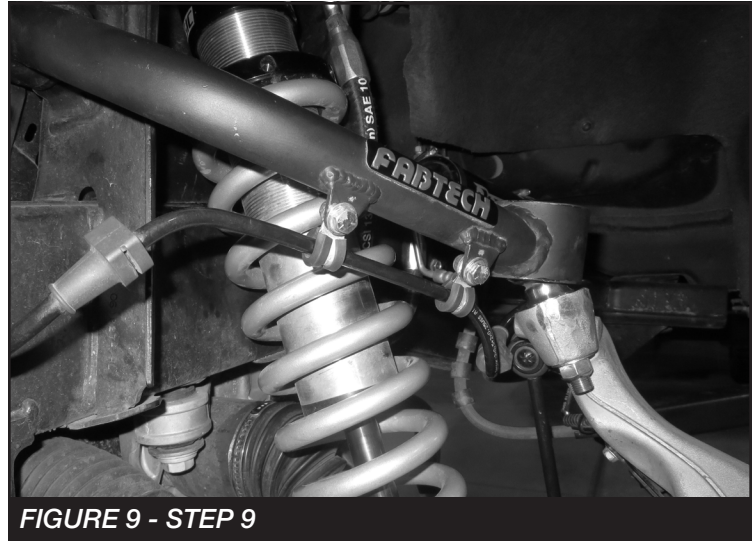

FIGURE 9 - STEP 9

10. Repeat steps on the passenger side.
11. Install tires and wheels and torque lug nuts to wheel manufacturer's specifications. Turn front tires left to right and check for appropriate tire clearance. **Note** - Some oversized tires may require trimming of the front bumper & valance.

12. Recheck all bolts for proper torque. **RE-TORQUE ALL NUTS, BOLTS AND LUGS AFTER 50 MILES AND PERIODICALLY THEREAFTER UNTIL TORQUE VALUES ARE RETAINED.**
13. Recheck brake hoses, ABS wires and suspension parts for proper tire clearance while turning tires fully left to right.
14. Check the fluid in the front and rear differential and fill if needed with factory specification differential oil. **Note - some differentials may expel fluid after filling and driving. This can be normal in resetting the fluid level with the new position of the differential/s.**
15. Check ball joints, uniballs bearings, bushings and all steering components every 2500-5000 miles for wear and replace as required.
16. Install Driver Warning Decal. Complete product registration card and mail to Fabtech in order to receive future safety and technical bulletins on this suspension.
17. Review all included warnings and warranties with consumer

For technical assistance call: **909-597-7800**

- Product Warranty & Warnings -

Fabtech provides a Limited Lifetime Warranty to the original retail purchaser who owns the vehicle, on which the product was originally installed, for defects in workmanship and materials.

The Limited Lifetime Warranty excludes the following Fabtech items; bushings, bump stops, ball joints, Uniball bearings, tie rod ends, limiting straps, cross shafts, heim joints and driveshafts. These parts are subject to wear and are not considered defective when worn. They are warranted for 60 days from the date of purchase for defects in workmanship.

Dirt Logic take apart shocks are considered a serviceable shock with a 1-year warranty against any manufacturer's defects. If a shock fails within the initial year of ownership, the owner must ship the shock to Fabtech for inspection and service. If after examination the shock is determined to have failed due to neglect, damage caused by improper installation, or any reason other than "normal wear and tear," the owner of the shock will be responsible for all service costs. Costs include labor, parts, and shipping. Service seal kits are available separately for future maintenance. All other shocks are covered under our Limited Lifetime Warranty.

Fabtech does not warrant any product for finish, alterations, modifications and/or installation contrary to Fabtech's instructions. Alterations to the finish of the parts including but not limited to painting, powder coating, plating and/or welding will void all warranties. Some finish damage may occur to parts during shipping, which is considered normal and is not covered under warranty.

Fabtech products are not designed nor intended to be installed on vehicles used in race applications or for racing purposes or for similar activities. This warranty does not include coverage for police, taxi, first responder vehicles, race vehicles, or vehicles used for government, commercial or fleet purposes. Also excluded from this warranty are sales outside of the United States of America.

Installation of most suspension products will raise the center of gravity of the vehicle and will cause the vehicle to handle differently than stock. It may increase the vehicle's susceptibility to a rollover, on road and off road, at all speeds. Extreme care should be taken to operate the vehicle safely at all times to prevent rollover or loss of control resulting in serious injury or death.

Oversized tires and wheels may decrease the vehicle's braking capacity. Drivers should always brake early and be aware of the increased the stopping distance of the vehicle. Drivers should adjust their driving habits to the effectiveness of the braking. Adjust your driving habits to these changes.

Failure to drive safely may result in serious injury or death to driver and passengers. Driver and passengers must ALWAYS wear your seat belts, avoid quick sharp turns and other sudden maneuvers